

Hand Operated Curtain Track Systems

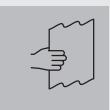



Hand Operated Curtain Track System

Silent Gliss® 6021 Safety Track

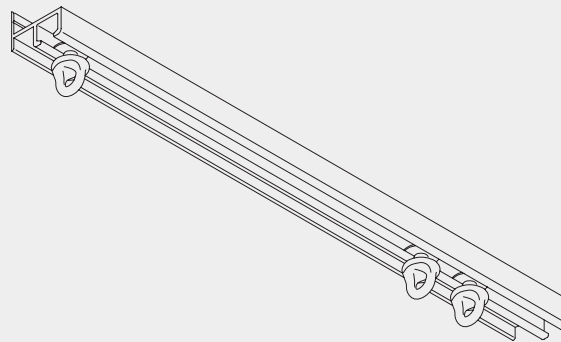

Product Information

- Wall fix safety track - unique gliders designed to separate from profile when a specific weight is applied (4-6kg)
- Discreet hand drawn curtain track for contract applications - ideal for hospital and schools
- Blue glider supplied for leading edge of curtain designed to separate at a higher weight (8-10kg) as more pressure is applied here when curtains are operated
- No gap between profile and wall
- For light to medium weight curtains
- White profile only
- Standard profile lengths available - 5m and 6m
- 6021 profile is not pre-drilled in order to prevent impairing appearance from the room
- Unique blue and yellow safety gliders for easy identification



6021

Profile, Bending and Specification Information

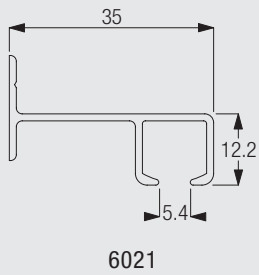

Specification Guide - download from www.silentgliss.co.uk (password required).

Silent Gliss 6021 hand operated curtain track in white powder coated aluminium. Fix track to wall with self drilling wood screws. Special gliders to run in profile 6148 (10/m) and 6149 (2/length). Fix with secure endcovers 6122 at either end.

Safety System Key Parts

Safety release function

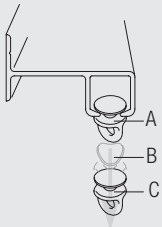

- A: Gliders can easily be clicked into profile
- B: Glider deforms under pressure
- C: Release under following pull weights: Glider 6148 (yellow for release between 4-6kg pull); Glider 6149 (blue for release between 8-10kg pull)

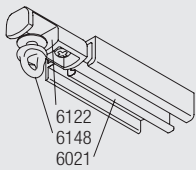

6122: Endstop (with end glider 6148 in place)

6021

6021/6290 system can assist in the prevention of self harm in hospitals, schools and psychiatric situations. Please see specific pull out weights on individual gliders. Please also note that the longer the individual track and the more gliders used, the cumulative total pull-out weight when in a stacked position will increase and therefore support more weight.

A risk assessment of the area should always be carried out.

Fitting Information

Maximum recommended fixing points



Important: when installing system 6021 with the intention of reducing the opportunity of self harm, Silent Gliss recommend the following:

- The first and final fixings must be no more than 1cm from either end of track.
- If fixing to a baton, ensure the profile does not project past the edge of the baton.
- If fixing to uneven wall surfaces (with or without batons), use a sealant or similar compound around the baton/track to ensure no gaps remain.

Fitting Options

Wall fix

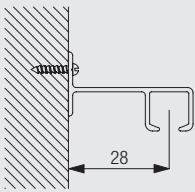

Standard Accessories

6021 Profile

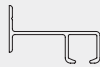

6122 Endstop

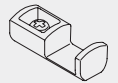

6021

6148 Safety glider (yellow)



6149 Safety glider (blue)



Optional Accessories

0688 Wood screw (self drilling)

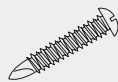

10430 Draw rod with hook, 50cm

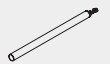

10431 Draw rod with hook, 75cm



10432 Draw rod with hook, 100cm

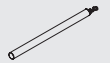

10433 Draw rod with hook, 125cm



10434 Draw rod with hook, 150cm

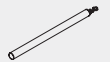

Useful Information and Sewing Accessories

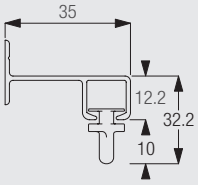

Diagram uses standard safety glider and is measured to the inside of the glider eye.

3582 Hook



3599 Hook



6021



6021

www.silentgliss.co.uk

www.silentglissglobal.com

Silent Gliss Ltd
Pyramid Business Park
Poorhole Lane
Broadstairs
Kent
CT10 2PT
Great Britain

Tel: +44 (0) 1843 863571
Fax: +44 (0) 1843 864503
info@silentgliss.co.uk

Silent Gliss Global Ltd
Pyramid Business Park
Poorhole Lane
Broadstairs
Kent
CT10 2PT
Great Britain

Tel: +44 (0) 1843 874250
Fax: +44 (0) 1843 874457
info@silentglissglobal.com